

ALI

Luminaire INNOVA

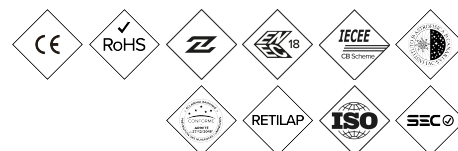
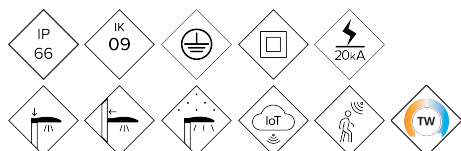

Flat environmental luminaire with an elipsoidal design ideal for urban residential areas (roads, squares, green spaces...). Ball joint mounting system. Power from 10W up to 100W thanks to its high dissipation capacity. Ready for any intelligent lighting control solutions.

MAIN FEATURES:

- High efficiency. Up to 145 lm/W real
- Adaptable by means of a ball joint, or suspended.
- Double cavity, Driver and Optical Group
- Easy opening without tools
- 18 different light distributions
- Zhaga Standard (Book 15)
- Ready 4IoT. Ready for connectivity

APPLICATIONS:

- Urban Roads and Streets
- Residential Streets (Zones 30)
- Cycle Lane and Narrow Tracks
- Rural Roads
- Parking

DETAILS:

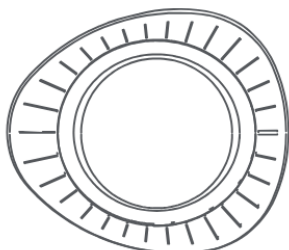

Design by Benito Research Center.

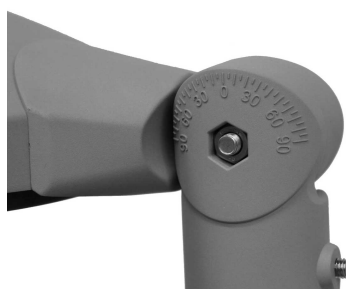

Fixing by ball-and-socket joint.



Opening without tools.

[Project sheet](#) | [CAD](#) | [Mounting instructions](#) | [BIM](#) | [HD image](#)

BENITO

info@benito.com
tel. 93 852 1000

SPECIFICATIONS :

Housing material:	Die-cast aluminium casting of type EN AC-43000, EN AC-43100, EN AC-43400, EN AC-44100, EN AC-47100 according to standard UNE EN 1706.
Diffuser (optic system enclosure):	5mm tempered glass, UV filtering. Polycarbonate available as an option.
Fixing elements:	18/8 Stainless Steel - AISI 304
Housing:	Double Cavity: Driver / LED Module
Sealing gaskets:	Silicone Foam
IP rating (luminaire):	IP66
IP rating (optic system):	IP66
IK rating (impact resistance):	IK09
LEDs thermal dissipation:	Heat dissipation through the luminaire body, without external fins or conductive fluids. Passive heat dissipation through convection, ensuring thermal contact between the LED modules through highly conductive heat transfer material.
Anti-condensation valve:	Pressure compensation valve that ensures moisture evacuation, preventing condensation and maintaining the luminaire's IP rating.
Paint and finishes:	Polyester powder coating, electrostatically sprayed and oven-sublimated. Corrosion-resistant.
Colour:	RAL 9022 and RAL 7043 colors (Optional: other colors on request)
Mounting:	Post - Top Fixation Ø60mm
Tilt range:	Adjustable luminaire from -90° to 90° inclination
Maintenance:	Easy to open without any special tools. Replaceable modules: LEDs, drivers, SPDs.
Recommended mounting height:	4 - 10 m
Driver:	Constant current driver, dimmable and programmable at different levels (0-10V, 1-10V, DALI2, NFC). Built into the luminaire, pre-wired on a steel plate. .
Flow Reduction:	Double level with control line, different timed levels or virtual midnight, flow reduction at the head.
Ready4IOT - Connectivity:	Zhaga Base (Book 18) - D4i. (Optional). NEMA 5,7 Pins Base (Optional). Bottom side Presence Sensor on Zhaga Base (Book 18) - D4i. (Optional).
Surge protection device (SPD):	Type T2+T3, 10-20kV and 20kA transient surge protector. Series connection with thermofuse, disconnection for a more effective protection at the end of the SPD service life. (Optional SPD Full Permanent Surge Protector >264Vac to <170Vac).
DarkSky Approved	The mount is pre-installed at 90 deg post top orientation, or 0 deg lateral mount orientation and non-adjustable.

DRAWING:

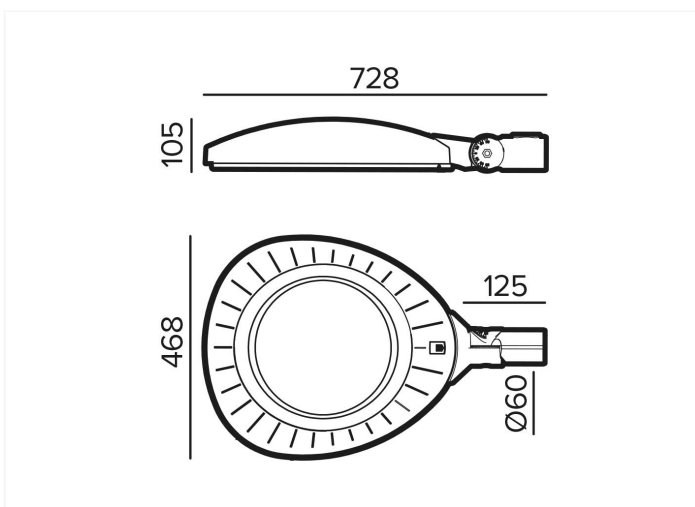

INSTALLATION:



TECHNICAL DATA:

INNOVA	REF.	Nº LEDs	Power W	I Driver mA	Real luminous flux (T) =85°C		Initial luminous flux (T) =25°C	
					Flux lm	Efficacy lm/W	Flux lm	Efficacy lm/W
		12	10	250	1420	142	1620	162
		12	20	500	2820	141	3215	161
		12	30	750	4260	142	4860	162
		24	40	500	5642	141	6432	161
		24	60	750	8443	141	9625	160
		36	80	667	11193	140	12760	160
		36	100	833	14066	141	16035	160

Luminous flux and efficiencies at 3000K and CRI>70 – Tolerance ± 3%
Approved by DarkSky with 3000K or lower

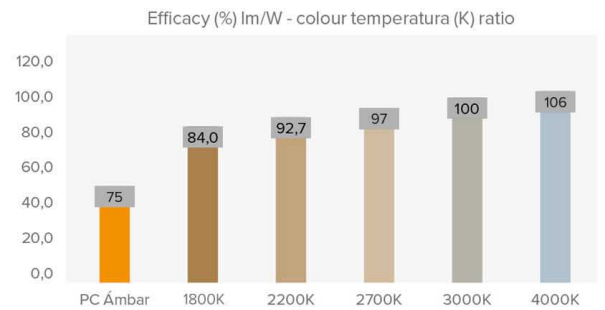

PHOTOMETRY:

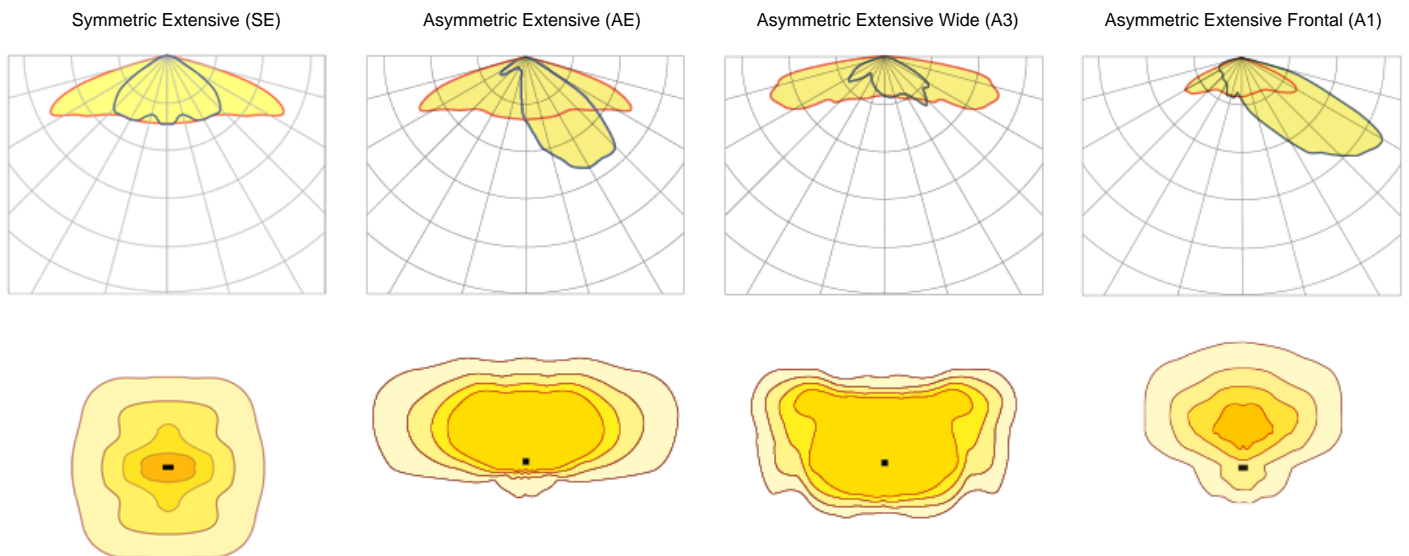

*Show 4 recommended lighting distributions. Refer to the 18 typologies.

LEDs MODULE:

LEDs module:	BENITO Zhaga format with 12 LEDs. See color temperatures, CRI, and light distributions. (NTC temperature probe optional).	
Replaceable module:	Yeah	
LED:	5050	
Number of LEDs:	12-24-36	
PCBs format:	2 or 3 Zhaga (Book 15) 2x4	
LED nominal efficacy:	172	
Colour temperature:	PC Amber - 1K8, 2K2, 2K7, 3K, 4K, TW - Tunable White	
Colour rendering index CRI:	>70 (optional >80)	
Average LED useful time L90B10:	L90B10 >100,000 hours	

OPTIC SPECIFICATIONS:

Optic system:	PMMA 2x2 lenses	
Light distributions:	18 light distribution curves. A1,A2,AE and SE distributions are DarkSky Approved	
Upward light output ratio ULOR:	0%	
Downward light output ratio DLOR:	100%	
Glare index:	Between D5 and D6 (depending on the light distribution)	
Luminous intensity category:	Between G*4 and G*6 (depending on the light distribution)	
Luminous flux CIE n°3:	>95% (See 18 Light Distributions).	
Photobiological safety:	RG0 (risk-free)	
Initial luminous flux Tj=25°C (up to):	lm	16035
Initial luminaire efficacy Tj=25°C (up to):	lm/W	160
Real luminous flux Tj=85°C (UNE EN 13032-4) (up to):	lm	14066
Real luminaire efficacy Tj=85°C (UNE EN 13032-4) (up to):	lm/W	141

ELECTRIC SPECIFICATIONS:

Nominal maximum power (LEDs):	90	
Maximum power consumed (luminaire):	W	100
Power range:	W	10-100
Maximum current of LED:	mA	<470 (LED Current = 50% Driver Current).
Power supply protection classes IEC:	Class I and II	
Surge protection device (SPD):	Type 2 and Type 3, 10-20kV and 20kA transient surge protector. Series connection with thermal fuse disconnecter for a more effective protection at the end of its service life.	
Common and differential mode protection (SPD) Udc:	kV	10
Max current (8/20) (SPD):	kA	20
Thermal phase disconnection (SPD):	Yes	
Input voltage:	Vac	220-240
Input voltage (max rate):	Vac	198-264
Input frequency:	Hz	47-63
Starting current:	A	<65
Duration of the starting voltage peak:	ms	<0.3
Driver efficacy:	>90%	
Power factor 100% consumption:	>0.98	
Power factor 50% consumption:	>0.95	
Total harmonic distortion (THD):	<10	
Power consumption on standby mode:	W	<0.4
Energy class:	C (According to EU Regulation 2019/2015 EPREL) - A++ IPEA>1.15	

OPERATING CONDITIONS:

Average LED useful time L90B10:	hours	>100,000
Average driver useful life to Tp <70°C:	hours	100,000
Average luminaire useful life L90B10 (TM-21):	hours	>100,000
Ambient temperature (Ta):	°C	From -35°C to +50°C
Aerodynamic resistance (CxS):	m2	0.076
Vibration test (15Hz 3 axis):		
Guarantee:	years	5 (extensible up to 10 years)

PACKAGING DIMENSIONS:

Net weight	kg	9
Gross weight	kg	9.5
Luminaire dimensions (LxWxH)	mm	728x470x105
Packaging dimensions (LxWxH)	mm	620x500x155
Pieces per box	1	
Quantity per container 20ft		
Quantity per container 40ft		

CERTIFICATES:

Security certificates:	EN 60598-1 / EN 60598-2-3 EN 62493 / IEC 62471
EMC certificates:	EN 55015 / EN 61547 / EN 61000-3-2 / EN 61000-3-3 EN 61347-2-13 / EN 61347-1 / EN 62384
Other certifications:	IEC 62262 / EN 13032-4 / EN 62717 / EN 6272-1 EN 6272-2-1 / EN 61643-11

Company Certifications



BENITO

info@benito.com
tel. 93 852 1000